

Panasonic®

Operating Instructions

Commercial Microwave Oven
Model NE-1056

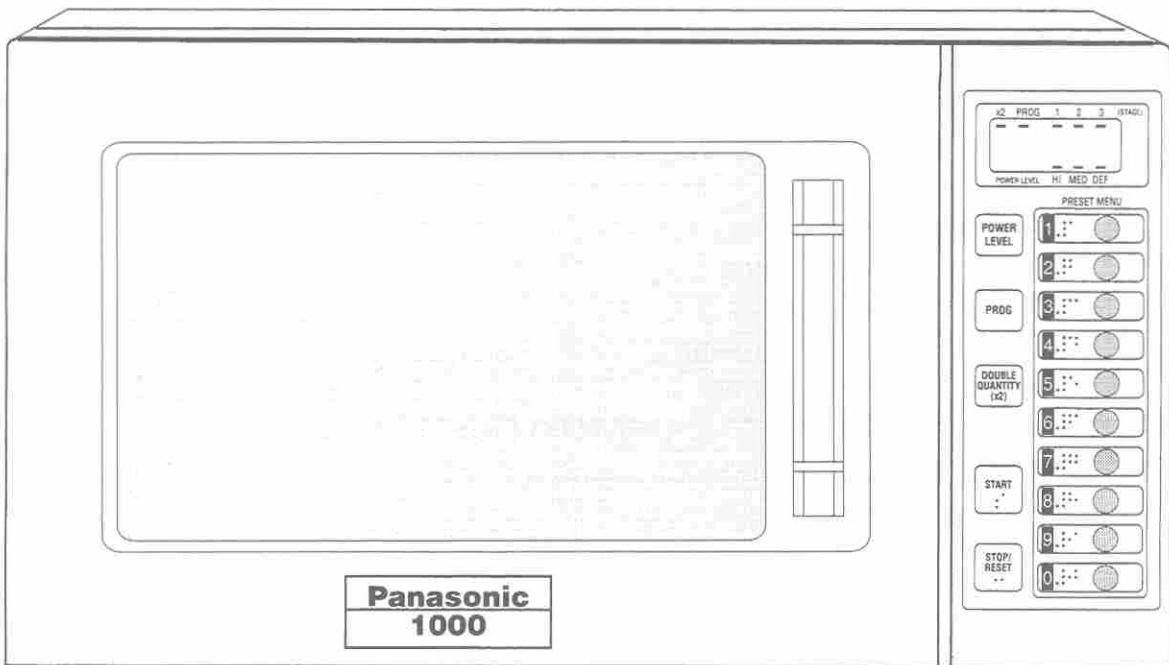

Before operating this oven, please read these instructions completely.

TABLE OF CONTENTS

PRECAUTIONS TO AVOID POSSIBLE EXPOSURE TO EXCESSIVE MICROWAVE ENERGY	3
IMPORTANT SAFETY INSTRUCTIONS	3
Installation and Grounding Instructions.....	4
How Does the Microwave Work?	5
Safety Statements.....	6
Outline Diagram	7
How to Operate	
Before Operating	8
Heating	
A. Manual Single Stage Heating.....	9
B. Manual 2 or 3 Stage Heating.....	9
C. Programmed Heating	10
Programming	
A. Programming Memory Pads for Single Stage Heating.....	11
B. Programming Memory Pads for 2 or 3 Stage Heating.....	12
C. Programming the Double Quantity Pad for Multiple Portion Heating	13
Other Features	
A. To Activate Program Lock.....	14
B. To Release Program Lock	14
C. To Read Program List.....	15
D. To Select Beep Tone Options	16
E. To Read the Cycle Counter	16
Self Diagnostics Failure Code Explanation (NE-1056).....	17
Care of Your Microwave Oven	17
Technical Specifications	19

Owner's Record

Model No. _____

Serial No. _____

The serial number of this product may
be found on the side of the oven.

Dealer's Name _____

Dealer's Address _____

Date of Purchase _____

Toll Free Service Information

To locate a convenient service agent call

1-888-350-9590

Chef support:

201-348-7305

IMPORTANT SAFETY INSTRUCTIONS

Your microwave oven is a cooking device and you should use as much care as you use with a stove or any other cooking device.

When using this electric appliance, basic safety precautions should be followed, including the following:

WARNING—To reduce the risk of burns, electric shock, fire, injury to persons or exposure to excessive microwave energy:

1. Read all instructions before using the appliance.
2. Read and follow the specific **"PRECAUTIONS TO AVOID POSSIBLE EXPOSURE TO EXCESSIVE MICROWAVE ENERGY,"** found at the bottom of this page.
3. This oven must be grounded. Connect it only to properly grounded outlet. See **"GROUNDING INSTRUCTIONS"** found on page 4.
4. Locate or install this appliance only in accordance with instructions provided.
5. Some items such as whole eggs and sealed containers—for example, closed glass jars—may explode and should not be heated in this oven.
6. Use this appliance only for its intended use as described in the manual. Do not use corrosive chemicals or vapors in this appliance. This type of oven is specifically designed to heat, cook, or dry food. It is not designed for industrial or laboratory use.
7. **Do not leave children alone** — Children should not be left alone or unattended in an area where appliance is in use. They should never be allowed to sit or stand on any part of this appliance. Do not allow children to use this appliance, unless closely supervised by an adult.
8. Do not operate this oven if it has a damaged cord or plug, if it is not working properly, or if it has been damaged or dropped.
9. This oven should be serviced only by qualified service personnel. Contact the nearest authorized service agent for examination, repair or adjustment.
10. Do not cover or block any openings on this oven.
11. Do not store this oven outdoors. Do not use this oven near water — for example, near a kitchen sink, in a wet basement, or near a swimming pool, and the like.
12. Do not immerse the cord or plug in water.
13. Keep the cord away from heated surfaces.
14. Do not let the cord hang over edge of the table or counter.
15. When cleaning the surfaces of the door and the oven that come together, use only mild, non-abrasive soaps or detergents applied with a sponge or soft cloth.
16. To reduce the risk of fire in the oven cavity:
 - (a) Do not overcook food. Carefully attend appliance if paper, plastic, or other combustible materials are placed inside the oven to facilitate cooking.
 - (b) Remove wire twist-ties from paper or plastic bags before placing bag in oven.
 - (c) If materials inside the oven should ignite, keep oven door closed, turn oven off, and disconnect the power cord, or shut off power at the fuse or circuit breaker panel.
 - (d) Do not use the cavity for storage purposes. Do not leave paper products, cooking utensils, or food in the cavity when not in use.

SAVE THESE INSTRUCTIONS

For proper use of your oven read remaining safety cautions and operating instructions.

PRECAUTIONS TO AVOID POSSIBLE EXPOSURE TO EXCESSIVE MICROWAVE ENERGY

- (a) **Do not attempt to operate this oven with the door open** since open-door operation can result in harmful exposure to microwave energy. It is important not to defeat or tamper with the safety interlocks.
- (b) **Do not place any object between the oven front face and the door**, or allow soil or cleaner residue to accumulate on sealing surfaces.
- (c) **Do not operate the oven if it is damaged.** It is particularly important that the oven door close properly and that there is no damage to the:
 - (1) door (bent)
 - (2) hinges and latches (broken or loosened)
 - (3) door seals and sealing surfaces.
- (d) **The oven should not be adjusted or repaired by anyone except property qualified service personnel.**

INSTALLATION AND GROUNDING INSTRUCTIONS

Examine Your Oven

Unpack oven, remove all packing material, and examine the oven for any damage such as dents, broken door latches or cracks in the door. Notify dealer immediately if oven is damaged. **Do NOT** install if oven is damaged.

Remove Protective Plastic Film

If a plastic film has been wrapped around the oven to protect the painted finish from scratching during shipping, please remove this plastic film prior to using the oven. (However, all ovens do not have plastic film wrapping.)

Placement of Oven

1. Oven must be placed on a flat, stable surface. For proper operation, the oven must have sufficient air flow. Allow 3 inches of space on both sides of the oven and 1 inch of space on top of oven.
 - a. **Do NOT** block air vents. If they are blocked during operation, the oven may overheat. If the oven overheats, a thermal safety device will turn the oven off. The oven will remain inoperable until it has been serviced and the safety switch is reset.
 - b. **Do NOT** place oven near a hot damp surface such as a gas or electric range.
 - c. **Do NOT** operate oven when room humidity is too high.

Grounding Instructions

This appliance must be grounded. In the event of an electrical short circuit, grounding reduces the risk of electric shock by providing an escape wire for the electric current. This appliance is equipped with a cord having a grounding wire with a grounding plug. The plug must be plugged into an outlet that is properly installed and grounded.

WARNING—Improper use of the grounding plug can result in a risk of electric shock.

Consult a qualified electrician or service person if the grounding instructions are not completely understood, or if doubt exists as to whether the appliance is properly grounded.

If it is necessary to use an extension cord, use only a three wire extension cord that has a three blade grounding plug, and a three slot receptacle that will accept the plug on the appliance. The marked rating of the extension cord should be equal to or greater than the electrical rating of the appliance.

Removal of Protective Film

A protective film is used to prevent scratching of the outer case during transportation. Peel the film from the exterior of the oven before installation or use.

Wiring Requirements

1. The oven must be plugged into at least a 20 AMP 120 VOLT, 60 Hz GROUNDED OUTLET.

Where a standard two-prong outlet is encountered, it is the personal responsibility and obligation of the user to have it replaced with a properly grounded three-prong outlet (Fig. 1).

Fig. 1



2. A TEMPORARY CONNECTION with a two-prong adapter may be made where LOCAL CODES PERMIT it (Fig 2). Unless the cover screw is grounded through the house wiring, attaching the adapter grounding plate to the cover screw will not ground the oven. If there is any doubt that the cover screw is grounded, have it checked by an electrician.

Fig. 2

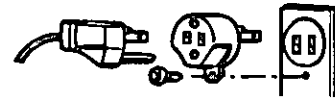

3. The oven must be on a SEPARATE CIRCUIT. No other appliance should share the circuit with the microwave oven. If it does, the branch circuit fuse may blow, or the circuit breaker may trip or the food may cook slower than the times recommended in this manual.
4. The VOLTAGE used must be the same as specified on this microwave oven (120V). Using a higher voltage is dangerous and may result in a fire or other accident causing oven damage. Using a lower voltage will cause slow heating. Panasonic is **NOT** responsible for damage resulting from the use of the oven with other than specified voltage.

How Does The Microwave Work?

Microwaves are a form of high frequency radio waves similar to those used by a radio including AM, FM and CB. They are, however, much shorter than radio waves; approximately five inches long. Electricity is converted into microwave energy by the magnetron tube. From the magnetron tube, microwave energy is transmitted and absorbed.

Reflection

Microwaves are reflected by metal just as a ball is bounced off a wall. A combination of stationary (interior walls) and rotating antenna, located underneath the bottom shelf assure that the microwaves are well distributed within the oven cavity to produce even heating or cooking of foods.

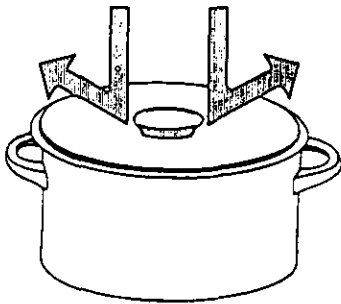

Absorption

During heating, microwaves will be absorbed by food. They penetrate to a depth of about $\frac{3}{4}$ to $1\frac{1}{2}$ inches. Microwave energy excites the molecules in the food (especially water, fat and sugar molecules), and causes them to vibrate at a rate of 2,450,000,000 times per second. This vibration causes friction, and heat is produced just as you will feel heat produced if you vigorously rub your hands together. The internal heating of larger foods is done by conduction. The heat which is produced by friction travels by conduction to the center of the food. Foods also continue to heat by conduction during standing time.

Because microwaves dissipate, much like sunlight as it reaches the Earth's surface, they are not stored in food.

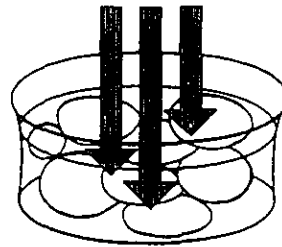

Transmission

Microwaves pass through some materials such as paper, glass and plastic much like sunlight shining through a window. Because these substances do not absorb or reflect the microwave energy, they are ideal materials for microwave oven heating containers.

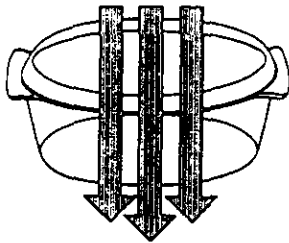

Radio Interference

1. Operation of the microwave oven may cause interference to your radio, TV or similar equipment.
2. When there is interference, it may be reduced or eliminated by taking the following measures:
 - a. Clean door and sealing surfaces of the oven. (See Care of Your Microwave Oven found on page 17.)
 - b. Place the radio, TV, etc. away from the microwave oven as far as possible.
 - c. Use a properly installed antenna, to obtain stronger signal reception.

Safety Statements

General Use

1. **Do NOT** tamper with or make any adjustments or repairs to door, control panel housing, safety interlock switches or any other part of the oven. **Do NOT** remove outer panel from oven. Repairs should only be done by a qualified service person.
2. **Do NOT** operate the oven if empty. The microwave energy will reflect continuously throughout the oven if no food or water is present to absorb energy.
3. If a fire occurs in the oven, turn the timer to the "0" position or press **Stop/Reset** Time Pad and **LEAVE DOOR CLOSED**. Disconnect the power cord, or shut off power at the fuse or circuit breaker panel.
4. **Do NOT** dry clothes, newspapers or other materials in oven. They may catch fire.
5. **Do NOT** use recycled paper products, as they may contain impurities which may cause sparks and/or fires when used.
6. **Do NOT** use newspapers or paper bags for heating.
7. **Do NOT** hit or strike control panel. Damage to controls may occur.
8. POT HOLDERS should always be used when removing items from the oven. Heat is transferred from the hot food to the heating container.
9. **Do NOT** store flammable materials next to, on top of, or in the oven. It could be a fire hazard.

Utensils

Use only containers and materials specified by their manufacturers to be for microwave use.

1. METAL CONTAINERS or dishes with metallic trims should not be used. Arcing may occur.
2. METAL TWIST-TIES may not be used in the microwave oven.
3. **Do NOT** use SEALED JARS or NARROW NECK bottles for cooking or reheating. They may shatter.
4. **Do NOT** use CONVENTIONAL THERMOMETERS in the microwave oven. They may cause arcing.
5. Remove PLASTIC STORE WRAPS, before heating in the oven.
6. When using foil, skewers, warming rack or utensils made of metal in the oven allow at least one inch of space between metal material and interior oven walls. If arcing (sparking) occurs remove metal material (skewers, etc.) and/or transfer to a nonmetallic container.

Food

1. HEATING TIMES given in the cooking guide are APPROXIMATE. Factors that may affect heating are: starting temperature, altitude, volume, size, and shape of foods and utensils used. As you become familiar with the oven, you will be able to adjust for these factors.
2. It is better to UNDERHEAT RATHER THAN OVERHEAT foods. If food is underheated, it can always be returned to the oven for further heating. If food is overheated, nothing can be done. Always start with minimum heating times.
3. SMALL QUANTITIES of food or foods with LOW MOISTURE content can burn, dry out or catch on fire if heated too long.
4. Microwave popcorn which pops in its own package is available. Each brand of microwave popcorn recommends that their popcorn be used in microwave ovens listed at a specific wattage. For example: "Use in a microwave oven 600 watts or greater", or "Tested in microwaves of 450 to 1000 watts." Follow popcorn manufacturer's directions and use a brand suitable for at least a 650 watts microwave oven.
5. Do not attempt to deep fat fry in your microwave oven.
6. Do not boil eggs in their shell in a microwave oven. Pressure will build up and the eggs will explode.
7. Potatoes, apples, egg yolks, whole acorn squash and sausages are examples of foods with nonporous skins. These types of foods must be pierced before cooking, to prevent bursting.
8. Liquids can become "superheated" in a microwave, and when the container is moved in any way, the **superheated liquids can "explode" out of the container.** "Superheated" water is hotter than boiling water, EVEN THOUGH IT DOES NOT APPEAR TO BUBBLE. To reduce the possibility of this occurrence: **Always make sure that liquids are stirred vigorously** before heating to assure that the liquid is mixed with air. NEVER HEAT LIQUIDS FOR AN EXCESSIVE LENGTH OF TIME.
9. Heat only 1 frozen dinner or entree in the oven at a time. If dinner or entree is heated in a foil tray, leave at least 1 inch of space between foil tray and oven walls.
10. Do not use paper towels or cloths which contain a synthetic fiber woven into them, such as nylon. The synthetic fiber may cause the towel or cloth to ignite.
11. Do not use the oven for any reason other than the preparation of food.
12. Your oven is equipped with a protective device designed to turn the unit off in the event of overheating. The oven will automatically reset itself after it has cooled. (approx. 30-60 min.)

Outline Diagram

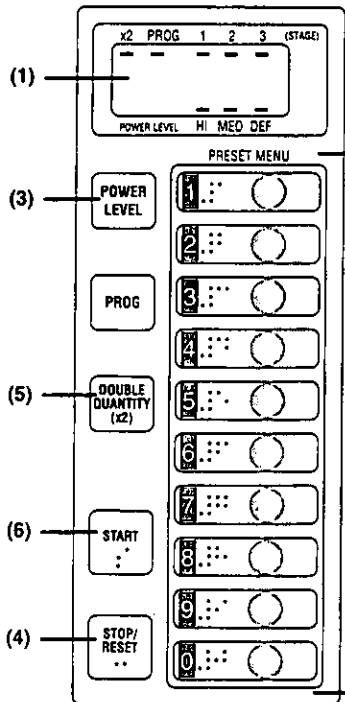

- (1) Digital Display Window (see below)
- (2) Memory Pads
- (3) Power Level Selector Pad
- (4) Stop/Reset Time Pad
- (5) Double Quantity Pad (x 2)
- (6) Start Pad
- (7) Control Panel
- (8) Door Safety Lock System
- (9) Oven Window
- (10) Oven Lamp
- (11) Splash Guard/Light Diffuser

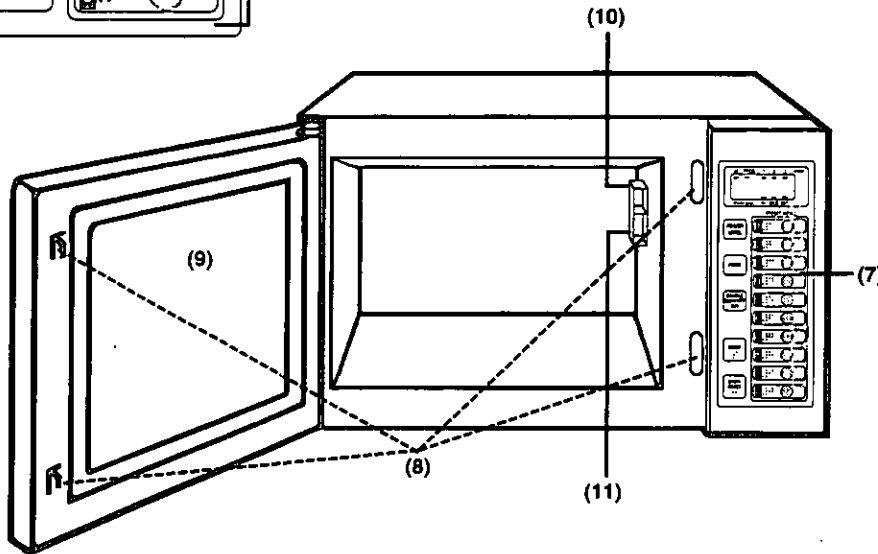

Digital Display Window Indicator Locations

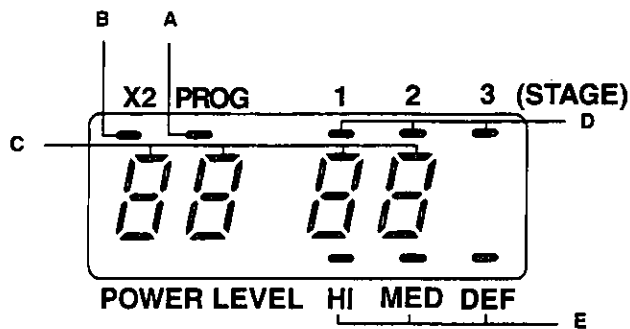

- A - Program Change Indicator
- B - Double Quantity (x2) Heating Indicator
- C - Memory Pad Number and Heating Time Display (min. sec.) - each indicator 0-9
- D - Stage Heating Indicator - 3 maximum

- E - Power Level Indicator
- HI (HIGH)
- MED (MEDIUM)
- DEF (DEFROST)

How to Operate

Before Operating

Make sure the oven is connected to a properly grounded electrical outlet. When the door is closed, the display is still blank. When the door is opened, the display shows "0". For the detail operation, see the page on each feature.

This oven is preset at the factory for the following:

1. Memory Pads preset to High Power at the indicated heating times for single stage heating.

1 – 10 sec.	6 – 1 min. 30 sec.
2 – 20 sec.	7 – 2 min.
3 – 30 sec.	8 – 2 min. 30 sec.
4 – 45 sec.	9 – 3 min.
5 – 1 min.	0 – 3 min. 30 sec.

The Double Quantity Pad (x2) preset to automatically double the programmed time of each Memory Pad.

Example: press  +  = 2 mins.

2. Program Unlock.
3. Cycle counter set to "0" on all pads.

To set the power level:

Select power level before programming the cooking time.



1 time . . .	HIGH
2 times . . .	MEDIUM
3 times . . .	DEFROST

FOR REFERENCE ONLY

100%
50%
35%

To set the cooking time:

You can set up to 99 minutes 99 seconds.

Example 1: To set 15 minutes 45 seconds

Press  →  →  → 

15 45

Example 2: To set 85 minutes 30 seconds

Press  →  →  → 

85 30



1H 25

When you press the START Pad, the display shows 1 hour 25 minutes instead of 85 minutes 30 seconds. When selected cooking time is over an hour, the display shows hours and minutes, but the oven works for your setting time.

Display:

The display will go blank (when the door is closed):

- at more than 1 minute interruption.
- at more than 1 minute after completion of heating and removing food.

The display will flash "0":

- continuously if food is not removed.

Oven Light:

Oven light will be turned on, when:

- you open the door.
- heating starts.

Oven light will be turned off, when:

- you close the door (no heating).
- heating finishes.

How to Operate







HEATING

Open the door and place food in the oven cavity. Close the door. "0" must be showing in the display window.

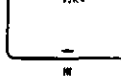
A. Manual Single Stage Heating:

This feature gives the user maximum flexibility to set the oven to desired heating time and power level. Ideal for menus that require various heating requirements.

Example: To heat for 2 minutes at High Power

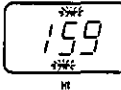
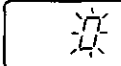
1.  •Press the **Power Level Selector Pad** one time. 
2.    •Press the **Memory Pads 2, 0 and 0.** 
3.  •Press the **START Pad.** Heating will start. The time on digital display will count down. 
4. Beep tone will sound. •All heating will stop. When opening the door, the display will stop blinking. 

B. Manual 2 or 3 Stage Heating:







This feature allows you to set to begin heating at one power level then shift automatically to a different power level after the designated amount of heating time.

Example: To heat for 2 minutes at Defrost Power for 2nd stage heating

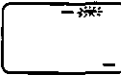
For Stage 1 cooking

1. Follow steps 1 and 2 above.

For Stage 2 cooking

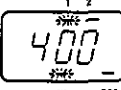
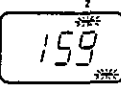
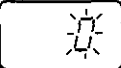
1.  •Press the **Power Level Selector Pad 3 times.** Indicator will change each time the pad is pressed. DEF is now displayed. Stage 2 is blinking. 
2.    •Press the **Memory Pads 2, 0 and 0.** 
3.  •Press the **START Pad.** The total time for both stages will be displayed. The Active Stage "1" and the Power Level "HI" blinks. The oven lamp will be turned on. Heating will start. •The total time will display and count down. •When oven shifts to the next stage, a single beep tone will sound. The Active Stage "2" and the Power Level "DEF" blink. 

4. Beep tone will sound. (See page 16) •All heating will stop. When opening the door, the display will stop blinking. 

NOTE:

For a 3 stage heating cycle, select a power level again and set the cooking time (steps 1 and 2 above).

SPECIAL NOTE: For both single and 2 or 3 stage heating.

1. While heating, one touch on the **STOP/RESET Pad** stops the oven. You can restart by pressing the **START Pad** or a second touch on the **STOP/RESET Pad** will cancel the selected program.
2. One touch on the **STOP/RESET Pad**, before the heating cycle is started, will cancel the selected program.

How to Operate

C. Programmed Heating:

Example: 1 stage; Memory Pad 9 to heat for 3 minutes at HIGH Power



•Press the Memory Pad 9.
In Program Lock Mode oven will start without pressing **START** Pad. See page 14.

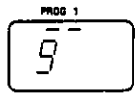

•Press the **START** Pad.
Heating will start.
The time on digital display will count down.



3. Beep tone will sound.
(See page 16)

•All heating will stop.
When opening the door, the display will stop blinking.

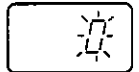

Example: 2 stage; Memory Pad 3 (to heat for 3 minutes at HIGH and 2 minutes at DEFROST)

See page 12 to program Memory Pad.
See page 14 to activate Program Lock.



•Press the Memory Pad 3.
In Program Lock Mode oven will start without pressing **START** Pad. See page 14.

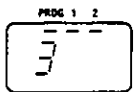

•Press the **START** Pad.
The total time for both stages will be displayed. The time on digital display will count down.
Heating will start.
•When the oven shifts to the next stage, a single beep tone will sound.



3. Beep tone will sound.
(See page 16)

•All heating will stop.
When opening the door, the display will stop blinking.

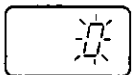

To Select Multiple Portion Heating:

The Double Quantity Pad (x2) is factory set to automatically double the programmed time for multiple portion heating.

Example: Memory Pad 5

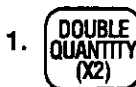

•Press the **DOUBLE QUANTITY** Pad.

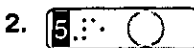
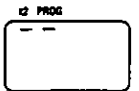

•Press the Memory Pad 5.
In Program Lock Mode oven will start without pressing **START** Pad. See page 14.

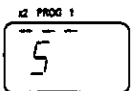

3. Follow steps 2 and 3 above.



How to Operate

Programming

— DO NOT OPEN THE DOOR —

The display window MUST be blank before programming can begin. If any indicator light is illuminated in the digital Display Window: close the door, press **STOP/RESET** Pad and wait 1 minute until the Display goes blank.



A. Programming Memory Pads for Single Stage Heating:

Example: To program 30 seconds at Medium Power for Memory Pad Number 5



•Press the **PROG** Pad.

NOTE:

- If no **PROG** Indicator appeared on display, "Program Lock" should be cancelled. (See page 14.)
- Do not keep pressing **PROG** Pad for more than 30 seconds, or a false failure code may result.

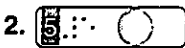
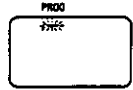

- Press the Memory Pad 5. The pad number and the previously selected time and power level will appear in the display.

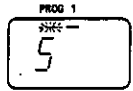

- The pad number and Stage Heating Indicator will appear in the display again.

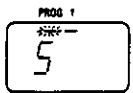

- Press the **Power Level Selector** Pad 2 times. The Memory Pad display will go out.



- Press Memory Pads 3 and 0.



- Press the **PROG** Pad again. You have completed programming the selected Memory Pad for single stage heating and double heating time for multiple portion heating automatically.

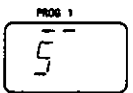

- 2 seconds later, the time and power level setting for single stage will appear in the display.



- 2 seconds later, Double Quantity Heating Indicator and then the double heating time will appear in the display.

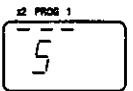

- 2 seconds later, the display will go blank.

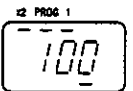

Memory Pad 5 is now programmed for heating - 30 seconds at MED Power

How to Operate

- NOTE:**
- Program the remaining Memory Pads as desired by repeating steps 1-5. You may insert up to 10 memory Programs.
 - When the **PROG** indicator is blinking, the program can be cancelled and/or the Pad erased by pressing the **STOP/RESET** Pad.

B. Programming Memory Pads for 2 or 3 Stage Heating:

Example: To program for 2 minutes at DEFROST for 2 stage heating using Memory Pad Number 5

1. Complete Steps 1 to 4 on page 11.

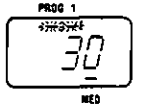

2. **POWER LEVEL**

- Press the **Power Level Selector Pad** 3 times. DEF indicator light will light.

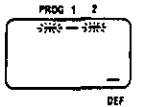

3. 

- Press the Memory Pads 2, 0 and 0.



4. **PROG**

- Press the **PROG** Pad again. You have completed programming the Selected Memory Pad for 2 stage heating and double heating time for multiple portion heating automatically.

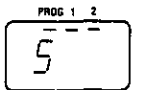

- 2 seconds later, the display will confirm your programming.

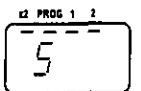

- Total time for 2 stage programming.



- After all of your programming has been completed, the display will go blank.



- NOTE:**
- Program the remaining pads as desired by repeating the steps above. **DO NOT OPEN THE OVEN DOOR** during programming.
 - For a 3 stage heating cycle, select a further power level and set the desired heating time between steps 3 and 4 above.

How to Operate

C. Programming the Double Quantity Pad — For multiple portion heating:

Your oven is factory set to automatically double the programmed time for multiple portion heating — this is the correct setting for heating multiple portions of most small food items. No further programming of the time is necessary for these food items.

The time required to heat multiple portions of some large platters and most bulk food loads is slightly less than double that of a single portion.

This model incorporates a Multiple Portion Heating Custom Program feature that allows you to customize the heating time and/or power level for multiple portions of your menu items.

For example, if Memory Pad 3 is set for 6 minutes at DEFROST, 12 minutes at DEFROST is set for double quantity heating automatically. However, if your own tests have determined that the correct heating times required is less (only 10 minutes 30 seconds at DEFROST) for two portions, the "Multiple Portion Heating Custom Program" feature can be programmed for 10 minutes 30 seconds at DEFROST.

Example: To program 30 seconds at HIGH Power on Memory Pad Number 2 (display must be blank)

1. 

• Press the **PROG** Pad.

NOTE:

- If no PROG Indicator appeared on display, "Program Lock" should be cancelled (see page 14).
- Do not keep pressing **PROG** Pad for more than 30 seconds, or a false failure code may result.

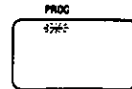

2. 

• Press **DOUBLE QUANTITY** Pad.

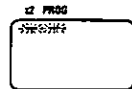

3. 

• Press the Memory Pad 2.
The pad number and the previously selected time and power level for multiple portion heating will briefly appear in the display.

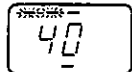
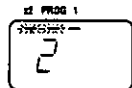

• The pad number and Stage Heating Indicator will reappear in the display.

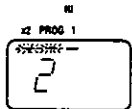

4. 

• Press the **Power Level** Selector Pad once. The Memory Pad display will go out.

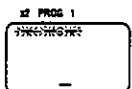

5.  

• Press the Memory Pads 3, 0.

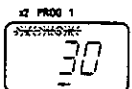

6. 

• Press the **PROG** Pad again. You have completed programming the selected Memory Pad for multiple portion heating.

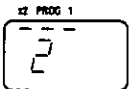

• 2 seconds later, the setting for single stage heating will appear in the display.

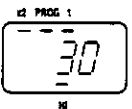

• 2 seconds later, the display will go blank.

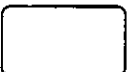

NOTE: • Program the remaining Memory Pad as desired by repeating steps 1-6 above. (You may insert up to 10 memory programs.)

DO NOT OPEN THE OVEN DOOR during programming.

• When the **PROG** indicator is blinking, the program can be cancelled and/or the pad erased by pressing **STOP/RESET** Pad.

How to Operate

Other Features

A. To Activate Program Lock:

This procedure "Locks" the control panel Memory Pads into their programmed heating times and power levels. **DO NOT OPEN THE DOOR.** The Display Window must be blank before the Program Lock feature can be activated.

1.

PROG

•Press and hold in the **PROG** Pad until the display shows "P" and "L". (for 6 seconds)

•Program Lock feature is now activated.

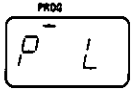
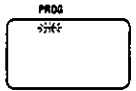

- NOTE:**
- Do not press **PROG** Pad for longer than 30 seconds continuously, or false failure code may result.
 - In "Program Lock"
 - a. To activate preset programs, open door will display "0".
 - b. The oven is started by pressing the desired Memory pad. There is no need to press the **START** pad.
 - c. The interrupt feature is deactivated—opening the door cancels the remaining time on the program.
 - d. The oven cannot be programmed until the program lock feature is deactivated.

B. To Release Program Lock:

This procedure deactivates "Program Lock" and activates all other features. Oven reverts to a 2 touch operating mode (Memory Pad plus **START** Pad). **DO NOT OPEN THE DOOR.** The Display Window must be blank before the Release Program Lock feature can be activated.

1.

**STOP/
RESET**

+

PROG

•Press the **STOP/RESET** Pad and while pressing this pad, press the **PROG** Pad until the display shows "P" (for 6 seconds).

•Program Lock Feature is deactivated.

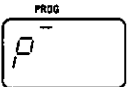
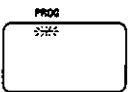

- NOTE:**
- Do not press **PROG** Pad for longer than 30 seconds continuously, or false failure code may result.
 - In "Program Unlock"
 - a. Repeat and interrupt features are operational.
 - b. Memory Pads can be programmed.
 - c. Tone loudness control is operational.

How to Operate

C. To Read Program List:

Allows you to review all currently programmed Pad Number, heating time and power level for each stage.

1. Open the door.

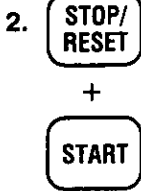

•While pressing the **STOP/RESET** Pad, press and hold in the **START** Pad. The Beep Tone setting will show in the display window.

Example: Stage Indicator 1: Beep tone is ON
Stage Indicator 2: Beep tone is OFF.

2 seconds later, the Program Lock setting will show in the display window.

Program Lock : "P L"
Program Unlock: "P"

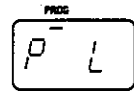

3.

•Press the Memory Pad you desired to read program.

Example: The Memory Pad Number 5. Display window will display; Program Memory Pad Number 5, first stage heating time and power level currently programmed on Memory Pad.

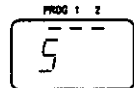

2 seconds later the same information will be displayed for the 2nd and 3rd stage heating.

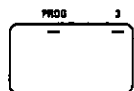
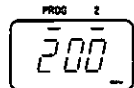

•After all settings have been displayed, the Pad Number and the Stage Heating Indicator will appear in the display again.

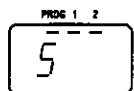

NOTE: •If you want to go to another program, press the Memory Pad you desire in order to read program, while the information of Memory Pad is being displayed.

•If you want to show the Multiple Portion Heating (x 2) program, press the **DOUBLE QUANTITY** Pad before pressing the Memory Pad.

How to Operate

D. To Select Beep Tone Options:

The Beep Tone can be set, ON or OFF.

1. Open the door.



2. 

• Press the **PROG** Pad. The display will not change.



3. 

• Press the Memory Pad.





• Repeat pressing of 0 Pad. Select "OFF" of Beep Tone.

Stage Indicator 1 = ON
Stage Indicator 2 = OFF

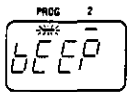

4. 

• Press the **PROG** Pad again. You have completed programming the beep tone.

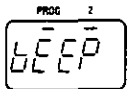

• 2 seconds later, "0" will appear in the display.

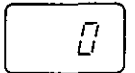

E. To Read the Cycle Counter:

The oven can display the total number of times the oven has been operated cumulatively. Great for analyzing usage of the oven and traffic flow at the location.

1. Open the door.



2. 

• While pressing **STOP/RESET** Pad, press **Power Level Selector** Pad. The display shows the total cumulative number of times the oven has been used.



+



Example:

- 9999 means, the oven has been used 999900 times.
- 0020 means the oven has been used 2000 times.
- If the total cumulative number of times less than 100 times, the display will not be changed.

• 2 seconds later, "0" will appear in the display window.

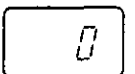

Self Diagnostics Failure Code Explanation

This oven monitors its operation and displays a Failure Code in the display window when a problem occurs.

What to do when a failure code appears:

CODE	CAUSE	WHAT TO DO
F01	*Overcooked food *Temperature of exhaust air too high.	*Press STOP/RESET Pad to stop beep. *Unplug oven and wait at least 30 minutes before reconnecting. *Wait for oven to cool down and reset. *If a flame is present, do not open oven door. *If normal operation does not resume, call the service agent with information of failure code.
F33-34	*Defective sensor circuit	* Unplug the oven and wait more than 10 seconds before reconnecting.
F44	*When a pad was pressed for more than 30 seconds *Defective pad or control circuit	* If normal operation does not resume, call the service agent with the information of failure code.

NOTE: Above codes shown in display do not indicate all the possible failures on the unit.

Care of Your Microwave Oven

1. Unplug the oven before cleaning.
2. Keep the inside of the oven clean. When food spatters or spilled liquids adhere to oven walls, wipe with a damp paper towel. Mild detergent may be used if the oven gets very dirty. The use of harsh detergent or abrasives is not recommended. The air intake splash guard/light diffuser can be removed for cleaning by removing the center plugs from the two plastic rivets. The top is held by two tabs. Wash in warm dishwater and replace.
3. The outside oven surfaces should be cleaned with a damp paper towel. To prevent damage to the operating parts inside the oven, water should not be allowed to seep into the ventilation openings.
4. If the Control Panel becomes wet, clean with a soft, dry cloth. Do not use harsh detergents or abrasives on Control Panel. When cleaning the Control Panel, leave oven door open to prevent oven from accidentally turning on. After cleaning, touch **STOP/RESET** Pad to clear display window.
5. If steam accumulates inside or around the outside of the oven door, wipe with a soft paper towel. This may occur when the microwave oven is operated under high humidity conditions and in no way indicates malfunction of the unit.
6. Clean off the grease and dust on bottom surfaces often. Use warm detergent solution.
7. Cleaning inside the oven outer panel and inside the oven base should be performed only by qualified service personnel after taking precautions to drain all stored voltage potential. The bottom is accessible by removing the center section of the base and the power and sensor control areas are within the outer wrap around housing. Avoid using liquids and cleaning solutions in these areas. Use a dry soft bristle brush or a cloth. Replace all parts— Do not connect the oven to the electricity supply if any parts are not reassembled.

Notes

Technical Specifications

	NE-1056
Power Source	120V, 60 Hz, single phase
Required Power	14.6 A 1680 W
Output*	1000 W
Frequency	2,450 MHz
Outer Dimensions (H x W x D)	12" x 20 $\frac{1}{8}$ " x 14 $\frac{1}{8}$ " (306mm x 510mm x 360mm)
Cavity Dimensions (H x W x D)	8 $\frac{1}{8}$ " x 13" x 13" (205mm x 330mm x 330mm)
Net Weight	Approx. 37 lbs. (16.8 kg)
Shipping Weight	Approx. 42 lbs. (19.0 kg)
Timer	99 min 99 sec (Digital) x 10 Memory Pads with Double Quantity (x2) Pad

*IEC 705-88 Test Procedure
Specifications subject to change without notice

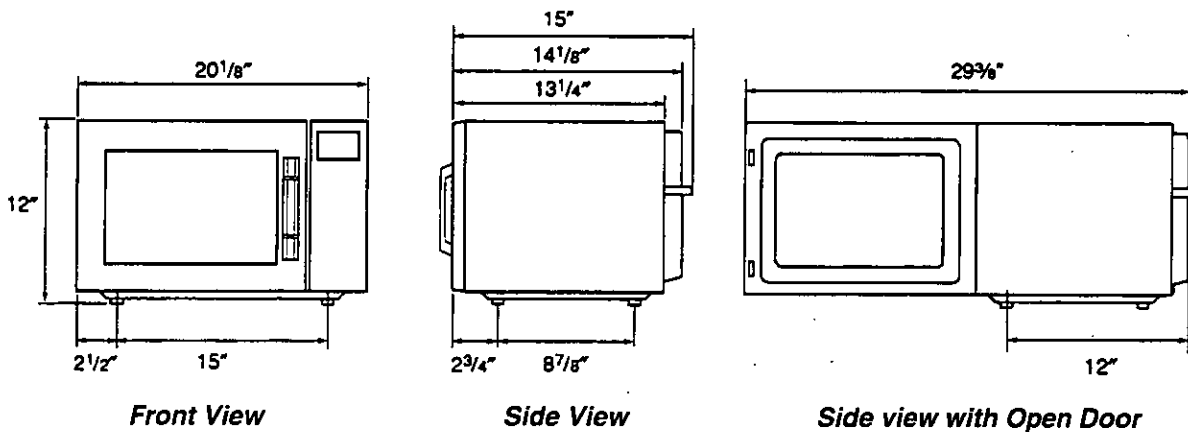

**MATSUSHITA HOME AND COMMERCIAL
PRODUCTS COMPANY, DIVISION OF
MATSUSHITA ELECTRIC CORPORATION OF
AMERICA**

One Panasonic Way, 4A-4, Secaucus, NJ 07094
(201) 348-5377

T00033700AP
Printed in Taiwan